



BOSCH

Climate 5000 L • Climate 5000iL

CL5000L 53 E • CL5000iL CF 53 E | CL5000L 70 E • CL5000iL CF 70 E |
CL5000L 105 E • CL5000iL CF 105 E | CL5000L 105 E-3 • CL5000iL CF 105 E |
CL5000L 140 E-3 • CL5000iL CF 140 E | CL5000L 160 E-3 • CL5000iL CF 160 E

bg	Голям климатичен уред сплит система	Ръководство за обслужване за потребителя	2
de	Large-Split-Klimagerät	Bedienungsanleitung für den Betreiber	12
el	Κλιματιστικό τύπου Split Large	Οδηγίες χρήσης για τον υπεύθυνο λειτουργίας	22
en	Large split air conditioner	Operating instructions for users	32
es	Climatizador Large Split	Manual de servicio para el usuario	41
fr	Climatiseur large split	Notice d'utilisation destinée à l'exploitant	51
it	Condizionatore Large Split	Istruzioni per l'uso per il gestore	61
nl	Large-Split-airconditioning	Gebruiksaanwijzing voor de exploitant	71
pl	Urządzenie klimatyzacyjne large split	Instrukcja obsługi dla użytkownika	81
pt	Ar condicionado split	Manual de instruções para o operador	91
ro	Aparat de aer condiționat de tip split Large	Instrucțiuni de utilizare destinate utilizatorului	101
sq	Kondicioner Large Split	Manuali i përdorimit	111
tr	4 Yönelimli Kaset Tipi Split Klima	Kullanıcılara Yönelik Kullanma Kılavuzu	120
uk	Спліт кондиціонер для застосування у приміщеннях великих площ	Інструкція з експлуатації для користувача	129

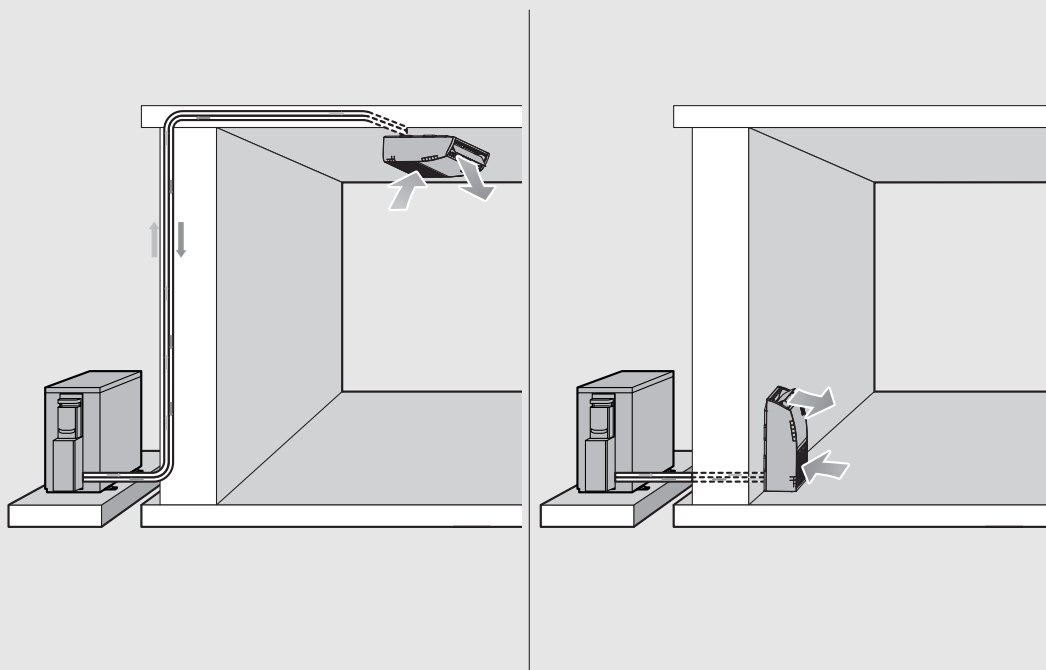

Table of contents

1	Explanation of symbols and safety instructions	32
1.1	Explanation of symbols	32
1.2	General safety instructions	33
1.3	Notices regarding these instructions	34
2	Product Information	34
2.1	Declaration of conformity	34
2.2	Specifications of remote control	34
2.3	Operating temperature range	34
2.4	Information on refrigerant	34
3	Operation	35
3.1	Unit overview	35
3.2	Indoor unit display	35
3.3	Remote control overview	35
3.4	Using the remote control	36
3.5	Louvre position memory	36
3.6	Setting main operating mode	36
3.7	Setting timer	36
3.8	Other functions	37
3.8.1	Setting the swing function	37
3.8.2	Changing over display and alarm buzzer (Mute Mode)	37
3.8.3	Energy saving functions	37
3.8.4	Noise reduction (Silent Mode)	37
3.8.5	Turbo cool/Turbo heat	37
3.8.6	Self-cleaning (I clean)	37
3.8.7	Indirect airflow (Wind avoid me)	37
3.8.8	Key lock function	37
3.8.9	Advanced operating functions	37
4	Troubleshooting	38
4.1	Faults with indication (Self diagnosis function)	38
4.2	Faults not indicated	38
5	Maintenance	39
5.1	Replacing the batteries	39
5.2	Cleaning the unit and the remote control	39
5.3	Cleaning the air filter	39
5.4	Decommissioning for longer periods	39
6	Environmental protection and disposal	39
7	Data Protection Notice	40

1 Explanation of symbols and safety instructions

1.1 Explanation of symbols

Warnings

In warnings, signal words at the beginning of a warning are used to indicate the type and seriousness of the ensuing risk if measures for minimizing danger are not taken.

The following signal words are defined and can be used in this document:



DANGER

DANGER indicates that severe or life-threatening personal injury will occur.



WARNING

WARNING indicates that severe to life-threatening personal injury may occur.



CAUTION

CAUTION indicates that minor to medium personal injury may occur.

NOTICE

NOTICE indicates that material damage may occur.

Important information



The info symbol indicates important information where there is no risk to people or property.





Symbol	Meaning
	Warning regarding flammable substances: the refrigerant R32 used in this product is a gas with low combustibility and low toxicity (A2L or A2).
	Wear protective gloves during installation and maintenance work.
	Maintenance by a qualified person should be done while following the instructions of the service manual.
	For operation follow the instructions of the user manual.

Table 1

1.2 General safety instructions

⚠ Notices for the target group

These operating instructions are intended for the operator of the air conditioning system. All system-relevant instructions must be observed. Failure to comply with instructions may result in material damage and personal injury, including danger to life.

- ▶ Read and retain the operating instructions of all system components prior to use.
- ▶ Observe the safety instructions and warnings.

⚠ Intended use

The indoor unit is intended for installation inside the building with connection to an outdoor unit and further system components, e.g. controls.

The outdoor unit is intended for installation outside the building with connection to an indoor unit or units and further system components, e.g. controls.

Any other use is considered inappropriate. Any damage that may result from misuse is excluded from liability.

For installation at special locations (underground garage, mechanical rooms, balcony or at any semi-open areas):

- ▶ First refer to the requirements for the installation site in the technical documentation.

⚠ General dangers posed by the refrigerant

- ▶ This appliance is filled with refrigerant. If the refrigerant gas gets into contact with fire, it may generate toxic gas.
- ▶ Have the system inspected and serviced regularly by an approved contractor.
- ▶ If there is a possibility that refrigerant has escaped, thoroughly ventilate the room and notify the approved contractor.

⚠ Conversion and repairs

If modifications to the air conditioning system are not carried out correctly, this can result in personal injury and/or material damage.

- ▶ Have work carried out only by an approved contractor.
- ▶ Do not make any changes to the outdoor unit, indoor unit or other parts of the air conditioning system.
- ▶ Disconnect the air conditioning system from the power supply before carrying out any maintenance work.

⚠ Notices on handling the system

If the air conditioning system is used incorrectly, this could impair your health.

- ▶ Do not stand directly in the airflow for any length of time.
- ▶ Ensure that the room temperature is suitable for all people in the room, including babies, children, elderly, bedridden or disabled people.
- ▶ Never insert objects into the unit, you could injure yourself.

If the unit is handled incorrectly, this can lead to reduced performance and also damage to the unit and personal injury.

- ▶ Do not block the air inlets and outlets of the unit.
- ▶ Shut doors and windows when the unit is in operation.
- ▶ Protect the indoor unit from water ingress.
- ▶ Check the outdoor unit mounting rack periodically for wear and to make sure it is firmly in place.
- ▶ Do not apply any weight to the outdoor unit, e.g. objects or persons.
- ▶ Keep dust, steam and moisture in the installation room of the indoor unit to a minimum.
- ▶ Do not use highly-flammable gases, e.g. from spray cans, in the vicinity of the units.
- ▶ If there appears to be something wrong with the air conditioner (burning smell or faulty cable for example), stop using it immediately and disconnect the power supply.

⚠ Safety of electrical devices for domestic use and similar purposes

The following requirements apply in accordance with EN 60335-1 in order to prevent hazards from occurring when using electrical appliances:

“This appliance can be used by children of 8 years and older, as well as by people with reduced physical, sensory or mental capabilities or lacking in experience and knowledge, if they are supervised and have been given instruction in the safe use of the appliance and understand the resulting dangers. Children shall not play with the appliance. Cleaning and user maintenance must not be performed by children without supervision.”

“If the power cable is damaged, it must be replaced by the manufacturer, its customer service department or a similarly qualified person, so that risks are avoided.”

1.3 Notices regarding these instructions

The figures are shown together at the end of these instructions. The text contains references to the figures.

Depending on the model, the products may be different to those shown in these instructions.

2 Product Information

2.1 Declaration of conformity

The design and operating characteristics of this product comply with the European and national requirements.

 The CE marking declares that the product complies with all the applicable EU legislation, which is stipulated by attaching this marking.

The complete text of the Declaration of Conformity is available on the Internet: worcester-bosch.co.uk.

2.4 Information on refrigerant

This device **contains fluorinated greenhouse gases** as refrigerant. The unit is hermetically sealed. The following information on the refrigerant complies with the requirements of EU Regulation No. 517/2014 on fluorinated greenhouse gases.

Product type	Rated cooling output [kW]	Rated heating output [kW]	Refrigerant Type	Global warming potential (GWP) [kg CO ₂ equ.]	CO ₂ equivalent of initial charge	Initial charge volume [kg]	Additional fill volume for pipe length L ¹⁾ [g/m]	Total charge volume during commissioning [kg]
CL5000L 53 E	5.28	5.57	R32	675	0.78	1.15	12	
CL5000L 70 E	7.03	7.62	R32	675	1.01	1.5	12	
CL5000L 105 E	10.55	11.72	R32	675	1.62	2.4	24	
CL5000L 105 E-3	10.55	11.72	R32	675	1.62	2.4	24	
CL5000L 140 E-3	14.07	16.12	R32	675	1.96	2.9	24	
CL5000L 160 E-3	15.24	18.17	R32	675	2.03	3.0	24	

1) Total pipe length L in metres (if L > 5 m simple path from outdoor unit to indoor unit).

Table 4 F-Gas

2.2 Specifications of remote control

Power infeed	2 AAA batteries
Signal range	8 m
Permissible ambient temperature	16... 30 °C

Table 2 Specifications of remote control

2.3 Operating temperature range

	Room temperature	Outside temperature
Cooling	16 ... 32 °C	0... 50 °C -15... 50 °C ¹⁾
Heating	0 ... 30 °C	-15... 24 °C
Dehumidifying	10... 32 °C	0... 50 °C

1) Product types with low-temperature cooling system

Table 3



The built-in protection device may prevent the appliance from operating at temperatures outside the above range.



If the humidity is more than 80 %, condensation may form at the air outlet. To prevent this, open the vertical ventilation flaps as wide as possible (vertical relative to the ground) and set a high fan output.



Notice for the user: If your installer adds refrigerant, he enters the added fill volume and the total amount of the refrigerant in the following table.

3 Operation

3.1 Unit overview

Indoor unit overview

Key to Fig. 1:

- [1] Louvre (on air outlet grille)
- [2] Condensate hose
- [3] Refrigerant line
- [4] Air intake grille (with air filter)
- [5] LCD display

3.2 Indoor unit display

Key to figure 3:

- [1] Manual operation
- [2] Status indicator
- [3] Timer indicator
- [4] DEF./FAN (defrosting and fan indicator)
- [5] Alarm indicator
- [6] Infrared signal receiver



The operating modes can be selected in the sequence **automatic mode**, **cooling mode** and **shutdown** via the Manual operation key.

Manual button





Operating mode	Display	Display output
Automatic mode	Operation indicator on	Cooling and heating modes: Set temperature Fan only mode: Indoor ambient temperature
Manual cooling mode	Status indicator flashes	The system automatically switches to automatic mode after 30 minutes of forced cooling. The remote control is deactivated during forced cooling.
Shutting-down	All indicators off	If the display is switched off, the indoor unit switches off and the remote control is reactivated.

Table 5 Indications on the display unit

3.3 Remote control overview

Keys on remote control

→ Fig. 3

Pos.	Button	Function
1		Switch on/off.
	Mode	Set operating mode.
		Eco operation mode
2	SET	Select advanced operating functions.
	OK	Confirm choice.
		Set timer.
		Increase temperature.
		Reduce temperature.



Pos.	Button	Function
3		Fan step
	Swing	Set swing function.
		Indirect airflow is active (Wind avoid me).
	Turbo	Turbo cool/Turbo heat
	LED	Switch display of indoor unit and alarm buzzer on and off (Mute Mode).
	Clean	Self-cleaning (I clean)

Table 6 Keys on remote control

Display of remote control

→ Fig. 5



















Pos.	Symbol	Explanation
1		Operating function: Sleep mode is active.
		Operating function: Follow Me function is active (Follow Me); temperature measurement at the remote control.
		Infographic: wireless control function
		Infographic: battery status
2		Operating mode: automatic mode
		Operating mode: cooling mode
		Operating mode: dehumidification mode
		Operating mode: heating mode
		Operating mode: Fan Mode
3		Value display: shows the set temperature, fan speed or (when timer is activated) the timer setting as standard.
		Infographic: transmission indicator; lights up when the remote control sends a signal to the indoor unit.
		Infographic: energy saving function active.
	GEAR	Infographic: energy saving function active.
		Infographic: ON/OFF timer active.
		Infographic: noise reduction is active (Silent Mode).
		Value display: shows the current fan speed. There are several output stages (bars) and the AUTO setting for automatic control
4		Infographic: automatic vertical swing function active (up/down). Alternative display of current position of horizontal louvre.
		Infographic: automatic horizontal swing function is active (left/right).
		Infographic: Turbo cool/Turbo heat is active.

Table 7 Symbols in the display

3.4 Using the remote control

The signal range is 8 m. If objects are in the way or certain fluorescent lamps are used in the same room this can affect transmission of the signal.

- ▶ Point the remote control towards the signal receiver window of the device and press the desired key.
The device emits a beep when it receives a signal.

NOTICE

The remote control may be permanently prevented from working correctly.

- ▶ Do not expose the remote control to direct sunlight.
- ▶ Do not leave the remote control near a heating appliance.
- ▶ Protect the remote control from moisture and impacts.

3.5 Louvre position memory

When the appliance restarts after a power failure, the louvres automatically revert to the position that was previously set. Press the **Manual operation** key on the indoor unit to restore the setting of the louvres.



Following adjustment, the angle of the horizontal louvres should not be too small, as otherwise condensate may form and drip into the appliance.

3.6 Setting main operating mode

Turn unit on/off

- ▶ Press the key to switch the unit on or off:
The unit starts in the set operating mode or switches off. To protect the unit it can only be switched back on after some time has passed.

Settings can also be made when the unit is switched off. The unit saves the settings, and also retains them in the event of a power failure.



After it has been switched off, the unit remains in standby mode. An automatic energy saving mode is enabled in standby mode due to intelligent On/Off technology (1 W standby).



Following a power failure the unit restarts automatically. This can lead to conflicting readings on the displays which are resolved automatically during operation.

Automatic mode

In automatic mode, the unit switches automatically between heating, cooling, fan and dehumidification mode, depending on the set temperature.

- ▶ Press the **Mode** key repeatedly until appears on the display.
- ▶ Select the required temperature with the and keys.



The fan speed cannot be adjusted in automatic mode.

Cooling mode

- ▶ Press the **Mode** key repeatedly until appears on the display.
- ▶ Press the key until the required fan speed is reached.
- ▶ Select the required temperature with the and keys.

Fan (Only) Mode

- ▶ Press the **Mode** key repeatedly until appears on the display.
- ▶ Press the key until the required fan speed is reached. **AUTO** can be selected to enable automatic control.



The temperature cannot be adjusted or displayed in fan mode.

Dehumidification mode

- ▶ Press the **Mode** key repeatedly until appears on the display.
- ▶ Set the required temperature with the and keys.



The fan speed cannot be adjusted in dehumidification mode.

Heating Mode

- ▶ Press and hold the **Mode** key until appears on the display.
- ▶ Set the required temperature with the and keys.
- ▶ Press the key until the required fan speed is reached.



If the outside temperature is very low, the heating capacity of the air conditioning system may not be sufficient. We recommend connecting additional heat sources.

3.7 Setting timer

ON and OFF timers can be set to between 0 and 24 hours, in 30-minute increments for the first 10 hours, then in 1-hour increments. If 0 hours is set, the timer is cancelled.

Setting the on timer

- ▶ Press the key until the symbol appears.
- ▶ Press the or key to set the desired time.
The setting is applied shortly afterwards.

Setting the off timer

- ▶ Press the key until the symbol appears.
- ▶ Press the or key to set the desired time.
The setting is applied shortly afterwards.

Cancelling timer

- ▶ Press the key to select the corresponding timer.
- ▶ Set 0.0 hours.
The timer is cancelled after a short time.

Combining timers

The two timers can be set at the same time. Either timer can be programmed to activate prior to the other

- ▶ Set the on timer and off timer.
The settings will be automatically combined.

Current time	13:00 o'clock
Setting of ON timer	4.0 h
Setting of OFF timer	8.5 h
Switch-on time	17:00 o'clock
Switch-off time	21:30 o'clock

Table 8 Example



You can not program the on timer and off timer to operate the unit at different temperatures or with other settings.

3.8 Other functions

3.8.1 Setting the swing function

NOTICE

If the louver remains at the lowest position during cooling mode for an extended period, condensate may form. Adjusting the louver by hand may cause faults.

- ▶ Only use the remote control to adjust the louver.

Automatic vertical swing mode (up/down)

- ▶ Press the **Swing** key until the symbol  appears.
- ▶ To cancel the automatic vertical Swing mode: press the **Swing** key again.

Swivelling the louver manually (up/down)

- ▶ Press the **Swing** key until the required position is set. The setting changes in the following sequence:

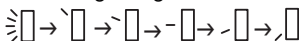

Automatic horizontal swing mode (left/right)

- ▶ Press the **Swing** key for longer than 2 seconds to activate the automatic horizontal Swing mode. The remote control displays the symbol .
- ▶ To cancel the automatic horizontal Swing mode: press the **Swing** key again.

Cleaning position

To make cleaning easier, the louver can be brought into a special position (depending on model).

- ▶ Press the **Mode** and **Swing** keys simultaneously for one second when the unit is switched off.
- ▶ To exit the cleaning position: press and hold both keys again.

3.8.2 Changing over display and alarm buzzer (Mute Mode)

- ▶ To switch on or off the display at the indoor unit and the alarm buzzer: press **LED** key.
- ▶ To display the current room temperature, press the **LED** key and hold for 5 seconds.
- ▶ To display the set temperature: press and hold the **LED** key for another 5 seconds.

3.8.3 Energy saving functions



Energy saving functions can only be selected in cooling mode.

The following energy saving functions can be selected at the device:

- **ECO**: operation with fan speed **AUTO** and set temperature of at least 24 °C
- **GEAR (75%)**: reduce power consumption by 25%
- **GEAR (50%)**: reduce power consumption by 50%
- None of the above symbols: normal operation
- ▶ To activate an energy saving function, press  key until the required function is displayed.



The **ECO** function automatically sets a temperature of 24 °C if the previously set temperature is lower. The function switches off as soon as the temperature is lowered to less than 24 °C.

3.8.4 Noise reduction (Silent Mode)

This function reduces the noises emitted by the indoor and outdoor unit when it is in operation. This is particularly advantageous at night, if you need to show consideration for your neighbours.

- ▶ During operation, press the  key for 2 seconds.

Exiting the function:

- ▶ Press the  key again for 2 seconds.

-or-

- ▶ Press the  key, **Mode** key, **Turbo** key or **Clean** key.



When the outdoor unit is in quiet mode, it may not be possible to achieve the required cooling/heating capacity because the compressor operates at a low frequency.

3.8.5 Turbo cool/Turbo heat

When Turbo cool/Turbo heat is active, the indoor unit operates at maximum power to heat or cool the room quickly.

- ▶ Turbo cool: switch on Cooling mode and press the **Turbo** key.
- ▶ Turbo heat: switch on heating mode and press the **Turbo** key.

Exiting the function:

- ▶ Press the **Turbo** key again.

3.8.6 Self-cleaning (I clean)

The device has a self-cleaning function for the evaporator. The self-cleaning freezes dust, mould and grease. Everything is then quickly defrosted and dried with hot air.

- ▶ To activate the self-cleaning: press the **Clean** key. **CL** appears on the display of the indoor unit when self-cleaning is in progress. Self-cleaning ends automatically after 20 to 45 minutes.

3.8.7 Indirect airflow (Wind avoid me)

- ▶ To activate the indirect airflow: press  key.

This function prevents a direct airflow on to persons.







The function is only available in cooling mode, dehumidification mode and Fan Mode.

3.8.8 Key lock function

The keys of the remote control can be locked with the keylock.

- ▶ To switch the keylock on/off: press the **Clean** and **Turbo** keys simultaneously for 5 seconds. The symbol  appears in the display when the keylock is active.

3.8.9 Advanced operating functions

- ▶ Press the **Set** key.
- ▶ Press the **Set** key or ,  keys to select the function.
 -  = Sleep mode
 -  = Follow Me function
 -  = Wireless control function
- ▶ Confirm selection with the **OK** key.

Exiting the function:

- ▶ Repeat the above steps.

Sleep mode

The purpose of this function is to save energy during idle times. After an hour, the device heats or cools less intensely. To do this, the set temperature is changed by 1 °C. After two hours, the set temperature changes by a further 1 °C. Then it remains at the new temperature.



The function is not available in dehumidification mode and Fan Mode.

Follow me function (Follow Me)

The function activates the remote control at the current location in order to measure the temperature at 3-- minute - intervals. The indoor unit is now controlled with reference to these measurements.



The Follow Me function is only available in cooling mode, heating mode and automatic mode.

Wireless control function

The purpose of this function is to establish a connection via WLAN.



To connect to WLAN an IP-Gateway (optional accessory) must be installed.

NOTICE

For TWIN installation, an IP gateway is sufficient for the master unit. No gateway is required for the slave unit.

4 Troubleshooting

4.1 Faults with indication (Self diagnosis function)

If a fault occurs during operation, the LEDs flash for an extended period or an error code is displayed (e.g. EH 02).

If a fault is present for more than 10 minutes:

- ▶ Briefly disconnect the power supply and switch the indoor unit back on.

If a fault persists:

- ▶ Call customer service and provide the fault code and details of the appliance.

4.2 Faults not indicated

If faults occur during operation that cannot be eliminated:

- ▶ Call customer service about the fault, providing details of the device.

Fault	Possible cause
The output of the indoor unit is too low.	Temperature is set too high or too low.
	Air filter is soiled and must be cleaned.
	Unfavourable ambient conditions for the indoor unit, e.g. the ventilation openings of the devices are obstructed, doors/windows in the room are open or the room contains powerful heat sources.
	Low-noise operation is activated and prevents the full output from being used.
Indoor unit does not switch on.	The indoor unit has a safety mechanism to prevent overloading. It may take 3 minutes, until the indoor unit can be restarted.
	The batteries of the remote control are empty.
	The timer is switched on.
Operating mode changes from Cooling or Heating to Fan Mode.	The indoor unit changes operating mode to prevent the formation of frost.
	The set temperature is reached provisionally.
A white mist is coming from the indoor unit.	In humid regions, white mist may appear if there is a significant temperature difference between the indoor air and air-conditioned air.
White mist is emerging from the indoor unit and outdoor unit.	If heating mode is activated directly after automatic defrosting, this can generate white mist due to the higher level of humidity.
There is noise coming from the indoor unit and outdoor unit.	A swooshing noise may be heard inside the indoor unit if the position of the airflow grille is set back.
	A quiet hissing noise is normal during operation. This is caused by the flow of refrigerant.
	Creaks and squeaks may be heard, as the metal and plastic parts of the device expand or contract during heating/cooling.
	The outdoor unit also emits a range of other noises during operation which is normal.
Dust is being discharged from the indoor unit or outdoor unit.	Dust may accumulate in the devices if they are shut down for an extended period and not covered.
Unpleasant odour during operation.	Unpleasant odours in the air may enter the devices and spread.
	There may be mould on the air filter and it must therefore be cleaned.
The fan of the outdoor unit is not running continuously.	Variable fan control is used to ensure optimum operation.
Operation is irregular or unpredictable or the indoor unit is not responding.	The indoor unit may be affected by interference from mobile radio masts or external signal amplifiers.
	▶ Briefly disconnect the indoor unit from the power supply then restart it.
Air baffle or louvres do not run correctly.	Air baffle or louvres have been adjusted manually or have not been correctly installed.
	▶ Switch off the indoor unit and check whether the components are engaged correctly.
	▶ Power on the IDU.

Table 9

5 Maintenance



CAUTION

Danger due to electric shock or moving parts

- ▶ Disconnect the power supply before carrying out any maintenance work.
- ▶ Have any maintenance steps that are not listed here carried out by an approved contractor.

5.1 Replacing the batteries

You require 2 size AAA batteries. Using rechargeable batteries is not recommended.

- ▶ Remove the battery cover (→ Fig. 6).
- ▶ Insert new batteries, ensuring correct polarity.
- ▶ Reinstall the cover.

5.2 Cleaning the unit and the remote control

NOTICE

Damage to unit due to incorrect cleaning!

- ▶ Do not directly splash or pour water onto them.
- ▶ Do not use hot water, thinner, abrasive powders or strong solvents.
- ▶ Clean indoor unit and remote control by wiping them with a soft cloth.
- ▶ Only have the outdoor unit cleaned by an approved contractor.

5.3 Cleaning the air filter

NOTICE

The air filter may deform in direct sunlight.

- ▶ Do not expose the air filter to direct sunlight.

Check the air filter every 2 weeks and clean if necessary. Always clean before and after decommissioning for longer periods.

- ▶ Switch off the indoor unit.
- ▶ Open the clip locks at the air intake and undo the screws on the clip locks.
- ▶ Open the air intake with a screwdriver.
- ▶ Detach the air grille from the appliance by folding it through approx. 45° and pulling it forwards.
- ▶ Pull out the air filter (→ Fig. 2).
- ▶ Clean the air filter using a vacuum cleaner, or wash out with hot water and a mild cleaning agent and dry in the shade.



If you clean the filter with water, the outer side of the air inlet grille should be facing downwards away from the water jet, and when cleaning with the vacuum cleaner it should be facing up towards the vacuum cleaner.

5.4 Decommissioning for longer periods

Before decommissioning for longer periods:

- ▶ Clean the air filter.
- ▶ Activate the self-cleaning of the indoor unit using the **Clean** button.
- ▶ After self-cleaning, switch on the fan mode until the indoor unit is dry.
- ▶ Turn off indoor unit and disconnect power supply.
- ▶ Take batteries out of the remote control.
- ▶ Protect the devices from dust.

6 Environmental protection and disposal

Environmental protection is a fundamental corporate strategy of the Bosch Group.

The quality of our products, their economy and environmental safety are all of equal importance to us and all environmental protection legislation and regulations are strictly observed.

We use the best possible technology and materials for protecting the environment taking account of economic considerations.

Packaging

Where packaging is concerned, we participate in country-specific recycling processes that ensure optimum recycling.

All of our packaging materials are environmentally compatible and can be recycled.

Used appliances

Used appliances contain valuable materials that can be recycled.

The various assemblies can be easily dismantled. Synthetic materials are marked accordingly. Assemblies can therefore be sorted by composition and passed on for recycling or disposal.

Old electrical and electronic appliances



This symbol means that the product must not be disposed of with other waste, and instead must be taken to the waste collection points for treatment, collection, recycling and disposal.

The symbol is valid in countries where waste electrical and electronic equipment regulations apply, e.g. "European Directive 2012/19/EC on old electronic and electrical appliances". These regulations define the framework for the return and recycling of old electronic appliances that apply in each country.

As electronic devices may contain hazardous substances, it needs to be recycled responsibly in order to minimize any potential harm to the environment and human health. Furthermore, recycling of electronic scrap helps preserve natural resources.

For additional information on the environmentally compatible disposal of old electrical and electronic appliances, please contact the relevant local authorities, your household waste disposal service or the retailer where you purchased the product.

You can find more information here:
www.weee.bosch-thermotechnologie.com/

Batteries

Batteries must not be disposed together with your household waste. Used batteries must be disposed of in local collection systems.

Refrigerant R32



The appliance contains fluorinated gas R32 (global warming potential 675¹⁾) mild combustibility and low toxicity (A2L or A2).

Contained quantity is indicated on the equipment outdoor unit name label.

Refrigerant is hazardous to the environment and must be collected and disposed of separately.

1) Based on ANNEX I of REGULATION (EU) No 517/2014 of the European Parliament and of the Council of 16 April 2014.

7 Data Protection Notice



We, **Bosch Thermotechnology Ltd., Cotswold Way, Warndon, Worcester WR4 9SW, United Kingdom**

process product and installation information, technical and connection data, communication data, product registration and client history data to provide product functionality (art. 6 (1) sentence 1 (b)

GDPR), to fulfil our duty of product surveillance and for product safety and security reasons (art. 6 (1) sentence 1 (f) GDPR), to safeguard our rights in connection with warranty and product registration questions (art. 6 (1) sentence 1 (f) GDPR) and to analyze the distribution of our products and to provide individualized information and offers related to the product (art. 6 (1) sentence 1 (f) GDPR). To provide services such as sales and marketing services, contract management, payment handling, programming, data hosting and hotline services we can commission and transfer data to external service providers and/or Bosch affiliated enterprises. In some cases, but only if appropriate data protection is ensured, personal data might be transferred to recipients located outside of the European Economic Area. Further information are provided on request. You can contact our Data Protection Officer under: Data Protection Officer, Information Security and Privacy (C/ISP), Robert Bosch GmbH, Postfach 30 02 20, 70442 Stuttgart, GERMANY.

You have the right to object, on grounds relating to your particular situation or where personal data are processed for direct marketing purposes, at any time to processing of your personal data which is based on art. 6 (1) sentence 1 (f) GDPR. To exercise your rights, please contact us via **privacy.ttg@bosch.com** To find further information, please follow the QR-Code.

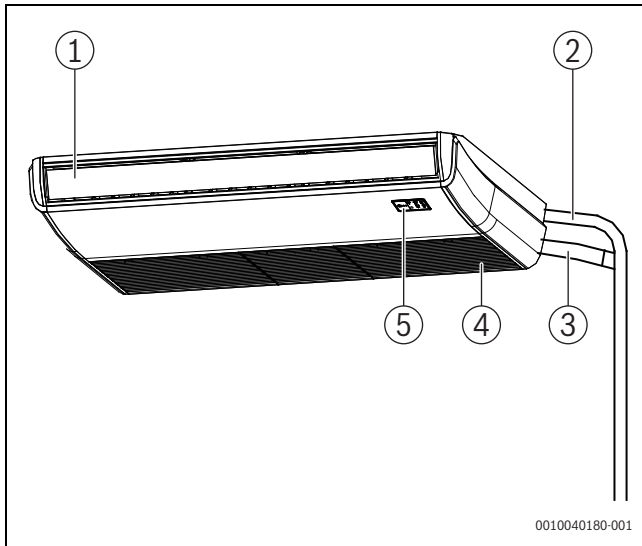

1

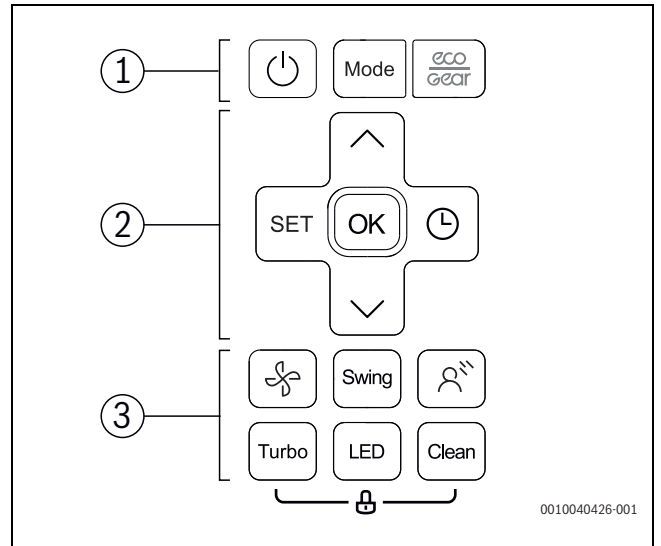

4

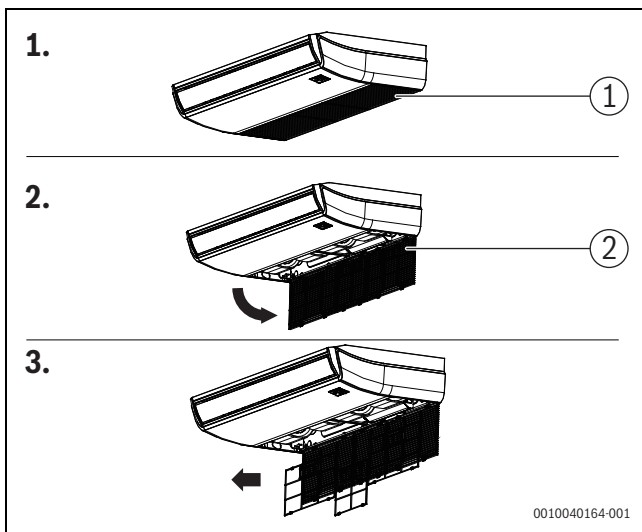

2

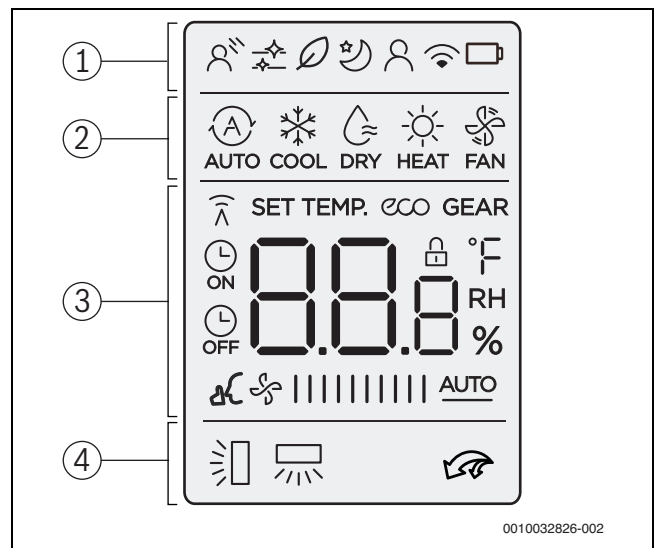

5

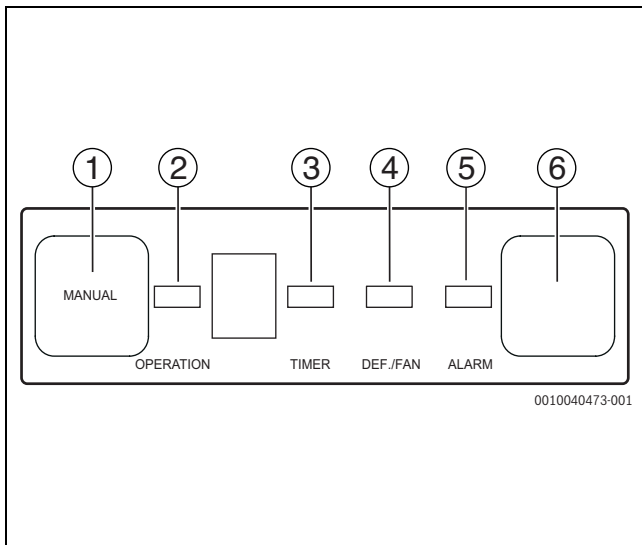

3

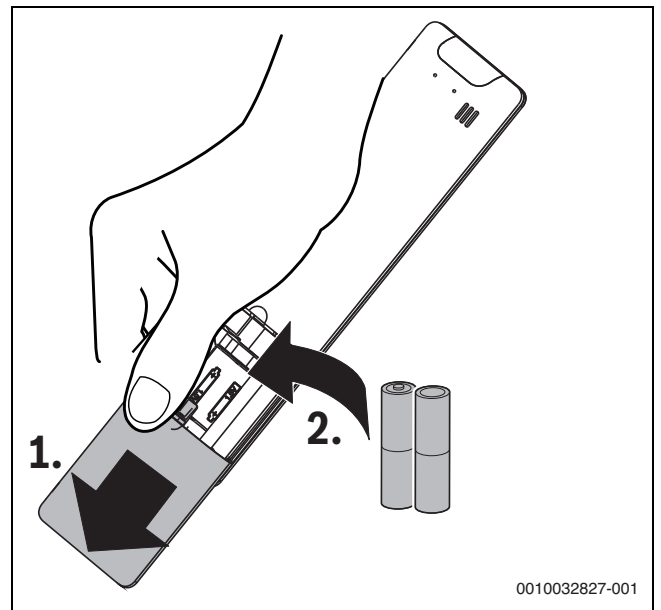

6

Bosch Thermotechnik GmbH
Junkersstrasse 20-24
D-73249 Wernau

www.bosch-thermotechnology.com